

Varenummer: 201139017
Beskrivelse: E+G Fingregreb
GN 7336-53-M10-50-NI

Mål

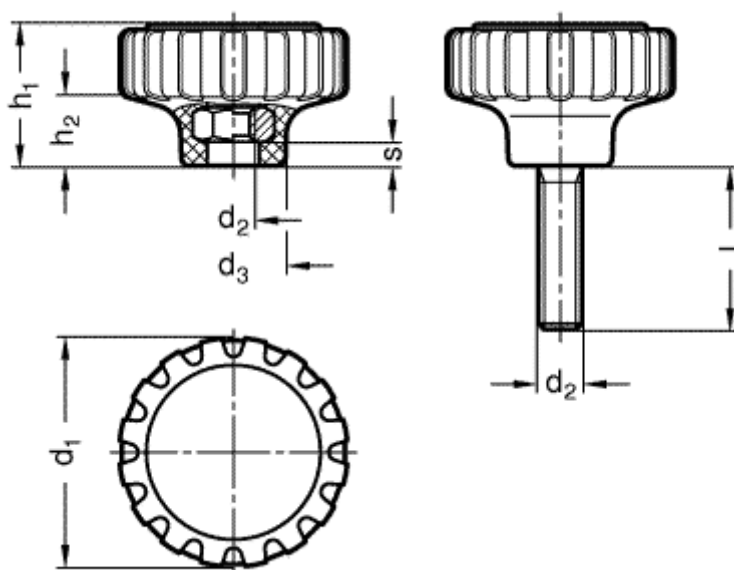

$d_1 = 53$
 $d_2 = M 10$
 $d_3 = 24$
 $h_1 = 31$
 $h_2 = 16$
 $l = 50$
 $s = 5$